

Growing Vegetable Transplants in Tennessee

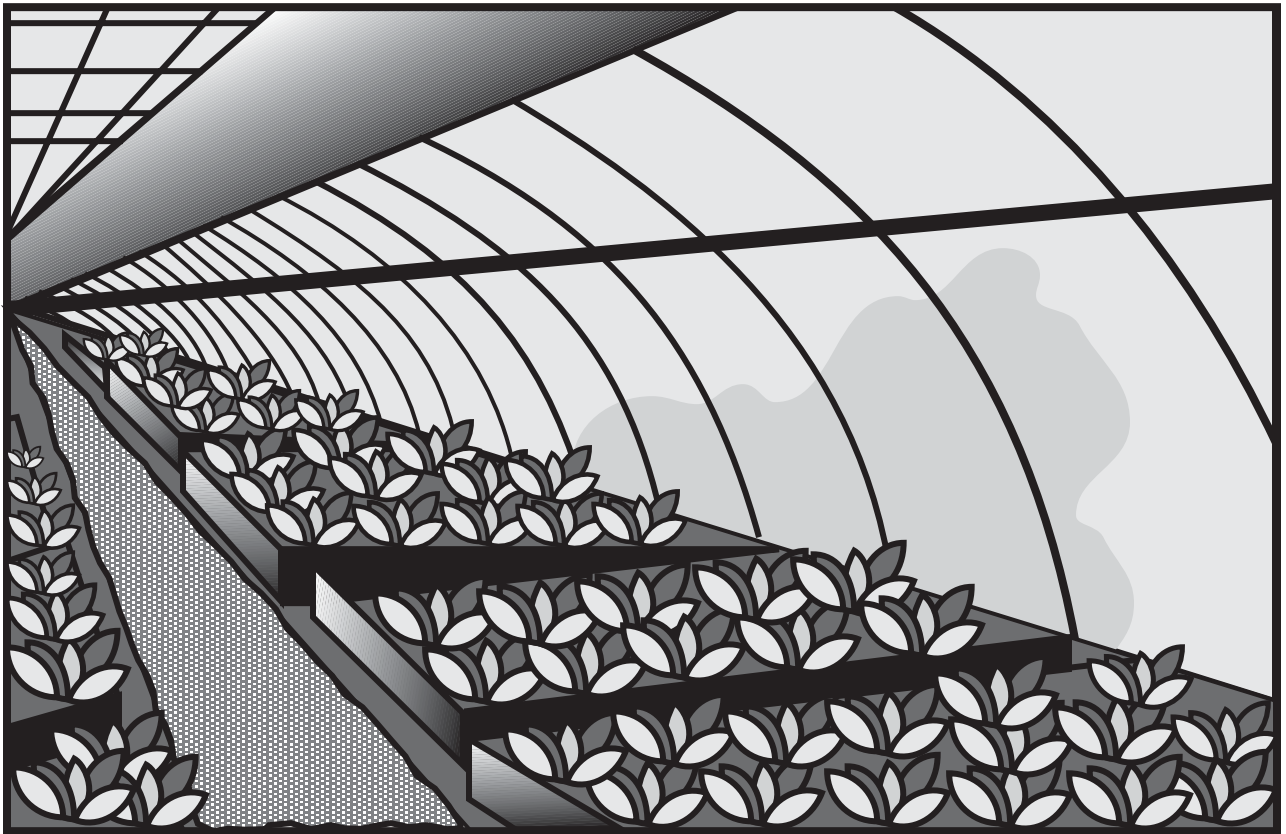

Contents

Introduction.....	3
Advantages.....	3
Disadvantages	4
Cultivar Selection.....	4
Plant-Growing Structures.....	5
Greenhouses.....	5
Site selection and orientation.....	5
Heating	5
Ventilation.....	5
Watering systems for greenhouses.....	5
Light transmission	6
Storage space for greenhouses.....	6
Plant float systems:	6
Tray sizes for float beds	6
Trays Required per 10,000 Plants	7
Materials for float beds	7
Growing media for float beds	7
Fertilizing plants grown in float beds	7
Seeding in float beds.....	8
Growth rate from fertilization	9
Aeration of water	9
Bed protection and heat	9
Plant-holding time in float beds.....	10
Hardening plants for field setting in the fall	10
Lettuce and mesculin greens	11
Conventional Plant-Growing Practices	12
Growing containers	12
Container size	12
Plant trays used for displays	13
Growing media for containers	13
Pre-formulated mixes	13
Soil mix	13
Homemade artificial media.....	13
Media sterilization	13
Chemical.....	14
Heat.....	14
Container and structure sterilization	14
Seeding.....	14
Mechanical seeders.....	15
Hand seeders.....	15
Space requirements for transplant production	16
Transplanting from seed containers	16
Management practices for growing transplants	16
Damping-off	16
Temperature	18
Day and night temperature management	18
Watering or irrigating.....	19
Light.....	19
Ventilation.....	19
Fertilization.....	19
Spacing	20
Diagnosing and Correcting Vegetable Transplant Disorders	20
Hardening Plants	20
Summary	20

Growing Vegetable Transplants in Tennessee

Alvin D. Rutledge, Professor Emeritus, Extension Plant and Soil Science

Introduction

The production of vegetable plants for commercial and home use is increasing in Tennessee. This is partially due to the expansion of greenhouse flower and ornamental production. To meet the demand for home gardeners, growers have gradually added vegetable plants to their spring production operation. Growers are finding that production of quality plants is a profitable business in urban areas.

Successful vegetable plant production is not a simple practice, because it requires technical knowledge of production practices within an enclosed environment, careful planning and management. Combining the required environmental conditions favorable for vegetable plant growth, either in a greenhouse or in a float bed, requires a thorough understanding of conditions suitable to plant growth. It is the intent of this publication to increase the grower knowledge of those requirements.

Commercial vegetable growers should grow their own plants to improve plant and fruit quality, as well as to increase the chances of harvesting when the supply is low and the price is high. Almost all of the larger tomato producers in East and West Tennessee are now producing many of their own plants. They are doing so because of the advantages involved.

Advantages

Production of homegrown plants has several advantages:

1. Growers can more easily control the growing environment, enabling better scheduling of transplanting when it best fits soil preparation and weather conditions. If the soil is too wet or the temperature is cold when plants are ready to set, they can be easily held without losing growth and yields until external environmental conditions improve.
2. Commercial growers can better select the cultivar that best suits their market needs. It is unwise to purchase plants of the first cultivar available if the market demands a specific size, shape, quality and color.
3. Home gardeners are better able to assure themselves of a good-quality plant when it is locally grown in containers rather than purchasing bare-root plants.
4. Plants produced by growers have a lower risk of disease infestation. Growers can implement their own practices to control disease and insect pests during the growing period. In addition, the plant growth rate can be better controlled through management of the fertility, water and ventilation programs.
5. The ability to choose container size is a distinct advantage for commercial vegetable growers. First, the larger the container (up to a point), the less shock a plant undergoes when transplanted to the field and the greater the marketable yields. Second, a plant produced in a larger container is usually harvested earlier than one grown in a smaller container. This can be a major economic advantage, depending on the crop being grown and its potential for early sales.
6. Grower-produced plants usually show much less stress than plants shipped bare-root. Reducing stress is a major concern when growing vegetables such as broccoli or cauliflower. They should never be stressed during the growing period or during shipment.
7. The maximum number of plants can be started from expensive seeds (hybrids) because of the better environmental control available over seeding out-doors. Good emergence reduces the cost of individual seed. For example, tomato seed that costs \$230 per 10,000 has an individual seed cost of \$0.023 each. However, if the percentage emergence drops to 70 percent, the cost of each seed goes to \$0.032 each; an increase of 42 percent, or about \$13 per acre for seed.

8. Growers have greater ability to harden the plants before they are transplanted to the field. This usually results in greater plant livability in the field and an increase in total yields due to greater plant uniformity and consistency of production.

Disadvantages

Growing transplants has several disadvantages. First, it requires a lot of knowledge about the conditions that influence plant growth and how those conditions affect yields and quality once plants have been transplanted to the field. Second, total yields can be influenced by the management program during the plant growing period. Growers need to know as many of those practices as possible to improve their production and marketing potential. For example, if a grower desires to increase the number of fruiting clusters on a tomato plant, it can be done through container size selection, the fertility and watering program and the temperature conditions under which growth occurs. Lower set of the first cluster can be promoted through container size selection, good light, proper watering and nutrient control.

Thirdly, the costs of the growing structure, containers, heating, ventilation and watering and other operation costs can become quite expensive per plant. However, a growing cost of \$0.15 per plant is not very expensive when the potential

return per plant is \$5 to \$8, but it may be very costly for a plant that can only gross a return of \$0.30 each. Growers will have to manage this carefully to keep the per-plant growing costs at a level that enables a potential profit. Finally, it will require a lot of time to properly manage and grow the plants. Plants will have to be protected during periods of extremely high temperature as well as during periods of low temperature and a possible heat system failure. Thus, it is advisable to have a back-up heating system available should the primary source malfunction. Water quality used to irrigate the plants should be high to reduce the potential for disease contamination.

Cultivar Selection

Successful vegetable production requires the growth of cultivars adapted to Tennessee and that are both desired and competitive within the market channels. Selection of an undesirable cultivar for specific markets can become an economic disaster for the commercial grower, but it is not a major problem for home gardeners. To aid the commercial grower in selecting cultivars, the Agricultural Extension Service has available **PB 418, “Recommended Commercial Vegetable Cultivars for Tennessee.”** It is revised and updated every other year, based on research conducted in Tennessee. It



Photo 1. Tomato plants being produced for field transplanting by a commercial grower.

provides descriptive fruit- and disease-resistant characteristics of many of the more common cultivars available to the Tennessee grower. Extension **PB 901, “Growing Vegetables in Home Gardens”**, also lists recommended garden cultivars. Both are available through your county Extension office. Refer to them for assistance in selecting cultivars for Tennessee.

Plant-Growing Structures Greenhouses:

Plastic or glass greenhouses are ideal structures for plant production. Currently, almost all greenhouses used for vegetable transplant production in Tennessee are covered with plastic. Plant growth under each type is quite satisfactory, but the initial investment is much greater with glass houses. Fuel costs are 30 to 40 percent less in houses covered with two layers of plastic rather than one, but plastic houses are not as durable as glass. Whether the house is covered with glass or plastic, the main features to consider are the site, adequate heating, ventilation, light transmission, watering facilities and plant bed arrangements to allow convenient and efficient handling of the plants.

If you desire greenhouse plans, contact your county Extension office and ask for a copy of one of the following plans:

Plan 795-3: Semi-Permanent Greenhouse

Plan 6094: Plastic-Covered Greenhouse

Site selection and orientation

Locate greenhouses in sunny areas with good surface drainage and easy access to high-quality water. Plan for easy access to the house and internal structures. Houses should be oriented north/south to allow maximum sunlight to reach the plants. The house illustrated in the following photograph is built on a south-facing slope, but it is built to fit the contour or elevation of the slope. There was no excavation done to level the floor of the greenhouse.



Photo 2. Greenhouse built to the slope. Stair-step beds keep plants growing on a level surface.

Rather, the growing platforms were constructed in step-like fashion to fit the existing slope and to provide a level surface for the plants.

Heating

Specific heating and temperature requirements will be discussed with specific subjects throughout the publication.

Ventilation

Adequate ventilation is needed to prevent excessively high temperatures during warm weather, and to keep the humidity as low as possible to reduce the potential for disease development. A fan and louvers with sufficient capacity to change the air once per minute are necessary. The fan and louvers should be thermostatically controlled, with both set to open simultaneously. Cooling fans should be set to start in sequence as the temperature in the greenhouse increases. The heating system should be capable of maintaining the air inside the house during cool periods high enough to reduce moisture condensation on the ceiling of the greenhouse. Foliage diseases can be reduced by pulling cool, outside air into the house, warming it up so it will pick up moisture and then exchanging it for cool air.

Watering systems for greenhouses

Some greenhouse growers have begun using automatic watering systems, while others use hand

watering. With automatic systems, moisture conditions are monitored visually and, when needed, automatic systems are turned on to provide moisture. Sprinklers are equipped with timers to shut the system down when enough moisture is applied. Some greenhouses are equipped with a sprinkler nozzle boom that covers the entire width of the greenhouse. They roll on rails from one end of the house to the other to apply a uniform application of water over the entire greenhouse, as illustrated in Figure 1. They are usually controlled by timing units to regulate the frequency of water application. The speed of movement along the rails is also controlled, depending on the amount of water to be needed per application. Always design watering systems that enable good access to the entire plant beds. The bed design may run either lengthwise of the greenhouse or the beds may be in peninsular form.

Other methods of watering include the use of hand-watering systems. Hoses equipped with fine-mist nozzles with water applied under low pressure are also often used.

Light transmission

Vegetable transplants require full sunlight to develop into strong, stocky plants. Therefore, the covering materials should allow transmission of as much of the total light spectrum as possible. Avoid excessive shade materials in growing vegetable transplants.

Storage space for greenhouses

Provisions for storing containers, necessary disease and insect control chemicals, growing media and sufficient work space to accomplish

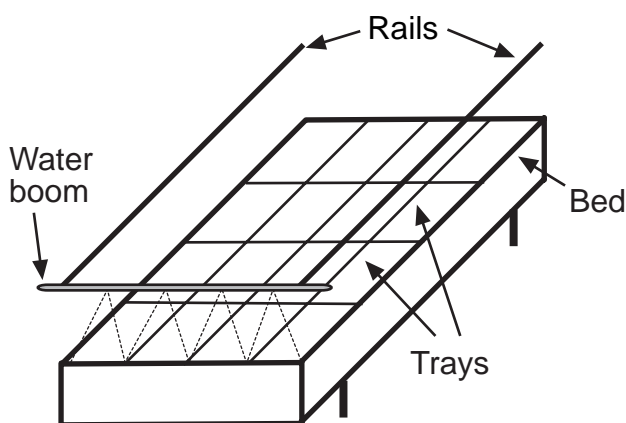

Figure 1. Automatic greenhouse watering system.

transplanting should be provided when constructing a greenhouse. This is usually done by constructing a “headhouse” in one end of the greenhouse or setting aside an adjacent area for seeding and preparation. Space requirements should include the necessary space for automatic container fillers and seeders. Individual beds can be constructed on rollers to enable movement of an entire bed for watering and maintenance purposes when working around the plants. Carts can be used to move transplant trays from greenhouses to wagons. Carts should be constructed to enable movement through the greenhouse. Smooth floor surfaces may be necessary to move the carts with ease.

Plant float systems:

The arrival of the “Float System” in the tobacco industry offers a new method of growing vegetable transplants. Basically, the “Float System” consists of placing float trays with 242 cells (or less, depending on the crop being grown) per tray on a nutrient-fortified and heated water bed that is covered for protection against the weather and to conserve heat (if spring plants are being grown). The bed can either be constructed inside a greenhouse or outdoors with the necessary means of providing protection and heat. One major advantage to the float system is that it offers a method of growing fall vegetable plants that Tennessee growers have not had prior to its development. Fall plants can be grown under minimally protected outside structures because of the temperature at the time plant growing occurs. This system allows for a very good, uniform-size transplant to be adequately and quickly produced for fall transplanting. It should provide Tennessee growers a much better opportunity to provide a fall product for the increasing fall market opportunities of certain vegetable crops in Tennessee. Using the float system, a grower does not have to be bothered about daily watering. An illustration of a float bed is provided in Figure 2.

Tray sizes for float beds

Float trays used in float beds are available in various cell sizes. They can be purchased in approximately the following number of cells per tray: 242, 200, 128, 95, 72, 42 and 18. An individual cell of a 242-cell tray is not likely to produce a large enough root ball for most vegetable plants to provide earliness and desired survivability. However, it does appear to be sufficient for green onions that

do not have to have more than a one-half inch bulb at market time. A 200-cell tray, however, seems to be quite suitable for cabbage, pepper, broccoli, cauliflower and collards. Tomatoes or the vine crops that require earliness are better adapted to the 42- or 95-cell tray, while lettuce (illustrated in photograph 4) that is to be grown to maturity will require a minimum size of 18 cells per tray. Tray dimensions are approximately 14 by 27 inches.

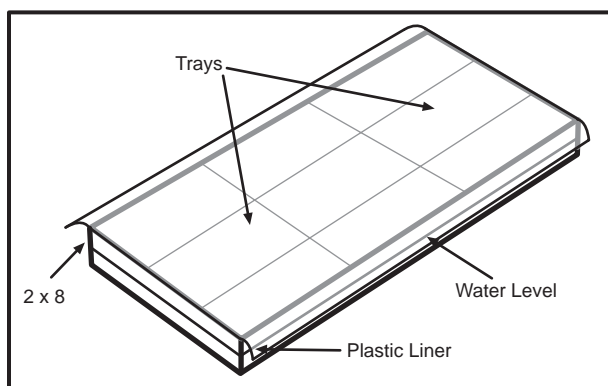

Figure 2. A 9-tray float bed illustration. Bed can be expanded to the desired size.

Trays Required per 10,000 Plants

The number of trays required per 10,000 plants is provided in Table 1.

Materials for float beds

Construction of a float bed requires a level site. Sides can be made of treated 2" x 6" x 8' lumber, or larger if necessary. Add 2 inches of sand in the bottom of the bed to protect the plastic liners and to assist in leveling the bottom of the bed. For spring production in outdoor beds, 1 inch of Styrofoam® insulation is laid in the bottom of the bed and attached to the internal sides. This reduces heat loss from the water into the adjacent soil underneath, but it may not be necessary for fall plants grown outdoors. Cover the insulation and the internal sides of the bed with two layers of 4 to 6 mil. black plastic. For spring plant production in outdoor beds, add sufficient water-heating capacity to maintain the water temperature at 75 degrees. Outdoor beds used for spring plant production will require more than water heaters to develop a good plant in the allotted growing time. The bed used for spring production will require a plastic cover to provide protection from cold temperatures and excessively cool winds. Beds used for production of outdoor fall

plants will need to be shaded to keep the germinating seedlings protected from direct contact with the sun. Once germination is complete and seedlings have reached the true leaf stage, they may then be moved into full sunlight.

Growing media for float beds

The growing media presently used with tobacco plants seems to be very suitable for most vegetable plants, as long as the water is fortified with an appropriate water-soluble fertilizer. There are several companies supplying growing media used in both tobacco and vegetable transplant production.

Fertilizing plants grown in float beds

The fertilizer most commonly available in Tennessee is a water-soluble 20-20-20. However, other suitable water-soluble fertilizers are available. Regardless of the fertilizer analysis used, base the amount on 100 ppm of N and K as provided in Table 2.

Monitor the fertilizer concentration with an electrical conductivity (EC) meter and adjust it in accordance with the draw-down that accompanies evapotranspiration. Some approximate EC readings for peat-lite soil mixtures are provided in Table 3.

The water pH should be in the 6.0 to 6.5 range for good plant root development. Avoid applying too much nitrogen. For tobacco plants, high levels may be desired, but this is not the situation with vegetables. High levels induce the growth of tall, tender plants that do not withstand adverse weather, nor will they be highly productive. **It is best for the nitrogen levels to be slightly below the necessary levels than to have excessive levels when growing vegetable plants.**

Table 1. Trays and area required for 10,000 plants based on tray size.

Tray Size (cells per tray)	Trays Required	Bed Area Required (square feet)
18	556	1,464
42	238	627
95	105	276
200	50	132
242	41	108

Table 2. Ounces of selected fertilizer materials required per 100 gallons of water for 50 ppm and 100 ppm nitrogen and potassium.

Fertilizer Material	Ozs. per 100 gallons of water	
	50 ppm N and K	100 ppm N and K
Ammonium nitrate+ Potassium nitrate	1.5 2.0	3.0 4.0
Sodium nitrate + Potassium nitrate	2.7 2.0	5.3 4.0
Calcium nitrate + Potassium nitrate	2.7 2.0	5.3 4.0
Urea + Potassium nitrate	1.0 2.0	2.0 4.0
12-12-12	5.25	10.5
15-0-15, 15-15-15	4.25	8.5
20-20-20, 20-10-20	3.20	6.3

Seeding in float beds

Many tobacco growers use modifications of the “Poor Boy Seeder” (**The University of Tennessee Agricultural Experiment Station Research Report 94-04, February 1994**) to enable seed

passage into the tray when they direct seed into the float tray. It includes a tray holder, a dibble board with a dibble for each cell and two plastic panels for seed alignment. The dibble board fits over each filled tray to form seed holes and two pieces of 1/16 to 1/8 inch plastic large enough to cover the entire tray and set on top of the tray holder. Each piece of plastic has a hole drilled through that is aligned directly over the center of each cell in the tray. Each piece of plastic is designed so that the lower one can be moved to dis-align the holes through each piece. With the holes unaligned, seeds are spread on the top piece and one seed is allowed to fill each hole. The lower piece is then slid into position to enable the holes to align. The seed then falls into the center of the cell directly underneath. This system works well for small-volume growers, but large-volume growers normally use mechanical seeders.

Table 3. Electrical Conductivity in Peat-lite Mixes.

EC Reading	Comments	Interpretations
3.5+	Excessive	Plants may be severely stunted.
2.25 to 3.5	Very high	Plants may grow adequately, but range is near danger zone, especially if soil dries.
1.26 to 1.75	High	Satisfactory for established plants. May be too high for seedlings.
0.51 to 1.25	Medium	Satisfactory for general plant growth. Excellent range for constant fertilization program.
0.0 to 0.50	Low	Low EC does no harm, but may indicate low nutrient concentration.

For spring plant production of cabbage, broccoli, cauliflower, kale and collards, seeding should be done in late January or early February for a late-March to early-April field transplanting date, depending upon the area of the state where production occurs. For spring tomatoes or peppers, seeding should be done in late February or early March for a late-April or early-May transplanting. All of the above crops may be seeded into seed trays and transferred to the float trays at the appropriate stage, or they may be seeded directly into the float trays.

For the vine crops (cantaloupes, cucumbers, squash or watermelons) seed them directly in the larger size cells (18 to 24) in early-April for field transplanting three to four weeks later. Vine crops, however, must have warm water temperature in the root zone or their growth will remain stunted throughout the growing season. The vine crops must be seeded directly into the float tray because the young seedlings do not normally survive when transplanted from one tray to another.

For fall production, start cabbage, cauliflower, broccoli and collards no later than July 15 to follow behind tobacco. Kale, on the other hand, can be started about two weeks later because it is a shorter-maturing crop. If fields are available, they can be transplanted during the last half of August, which usually allows enough time to mature. All of these crops, except kale, must be in the field by August 20 to provide sufficient time for them to mature before freezing weather occurs. The maturity will depend on the variety selected. A long-maturing variety will need to be planted before August 20, while a short-maturing variety will need to be used at that time.

When direct seeding into float trays, fill the cells with moist media and firm it down. Use a rolling dibble, if available, and make a depression about twice the diameter of the seed in the top of the media, insert the seed and cover with media. The trays can then be moistened and stacked for three or four days until seeds begin to emerge, or they may be immediately placed on the water bed. However, growers may find that moistening the media and stacking the tray for three or four days in a warm area may increase the percentage of seed emergence. Immediate floating could result in water saturation around the seed and impede germination, especially if the water is not at the proper temperature.

Growth rate from fertilization

When plants receive more than the levels of fertilizer indicated in Table 2 per-100 gallons of water, their growth rate may become too rapid, resulting in spindly plants with a low survivability rate. For example, one pound of 20-20-20 water

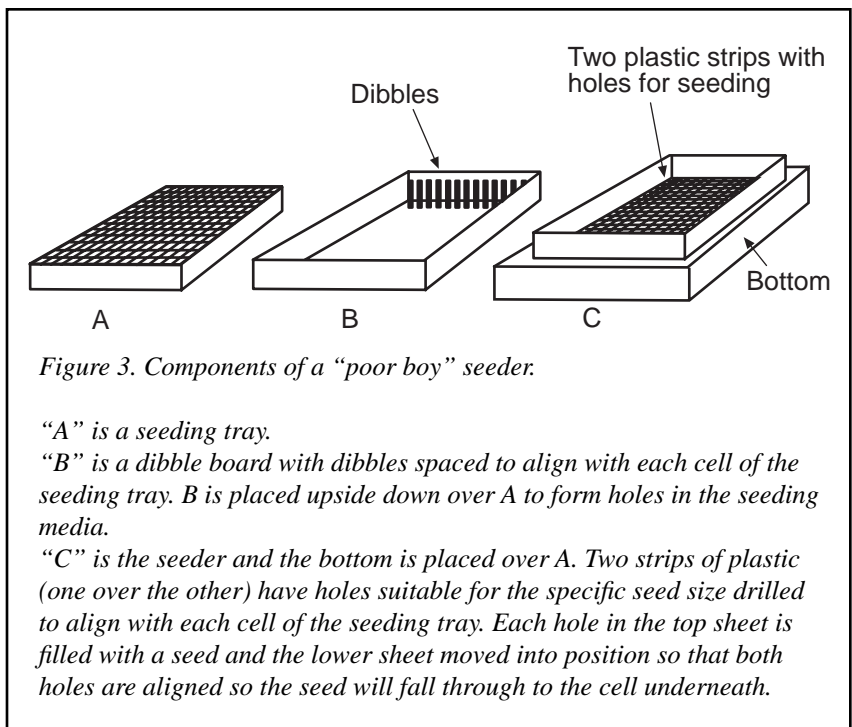

Figure 3. Components of a "poor boy" seeder.

"A" is a seeding tray.

"B" is a dibble board with dibbles spaced to align with each cell of the seeding tray. B is placed upside down over A to form holes in the seeding media.

"C" is the seeder and the bottom is placed over A. Two strips of plastic (one over the other) have holes suitable for the specific seed size drilled to align with each cell of the seeding tray. Each hole in the top sheet is filled with a seed and the lower sheet moved into position so that both holes are aligned so the seed will fall through to the cell underneath.

soluble fertilizer per 100 gallons of water produced 19-inch tomato plants in five weeks when grown in the summer under protected beds. That level appears to be toxic to cabbage plants grown under the same conditions. In an on-farm demonstration with green onions, the 8-ounce level appeared to stimulate too-rapid growth, resulting in onion tops that tended to fall over before harvesting occurred. Local wholesalers turned them down because of this problem.

Aeration of water

Research and on-farm demonstrations on constant aeration of the water underneath the trays has produced mixed results. David Coffey aerated cabbage plants being grown for fall production in out-door beds in 1998 at the Plant Science Farm in Knoxville and observed that transplant growth was much faster and harvest was earlier than from plants grown under non-aerated conditions. Jim Wyatt, working with tomatoes at West Tennessee in Jackson, did not observe added growth from aeration. On-farm demonstrations with tomatoes in Cocke County did not indicate a greater rate of growth than those under non-aerated conditions.

Bed protection and heat

Whether for spring or fall production, beds should be protected from severe weather conditions.



Photo 3. Strawberry plants being grown in out-door float bed.

Cold temperatures will be a problem in the early spring, while hot weather will be a problem for fall production. Spring beds will require supplemental heat. If a greenhouse is used, it should provide sufficient heat. If outdoor beds are used, there should be a protective cover over the plants and a heat source both above them and in the water to keep plants growing.

For fall production, an outdoor bed covered with a shade cloth such as tobacco canvas and well ventilated while the plants are emerging and are in the young, seedling stage will provide the necessary protection. This will keep them from being killed or severely damaged from direct exposure to the sun and high temperatures.

Plant-holding time in float beds

Under Tennessee conditions, the research station as well as some local, on-farm cooperators have been unable to hold plants in the float system more than about six weeks with broccoli, cabbage and tomatoes. Green onions have remained longer before root decay and root tissue damage occurs. Usually, a large amount of roots will form in the water below the tray and root tissue will slough off after about six

weeks in the water unless the water is aerated. This will begin to result in plant death in the bed and slow recovery once transplanting to the field occurs. When a large root system occurs in the water and plants have to be removed from the cells, roots are removed during plant removal from the trays.

Hardening plants for field setting in the fall

When vegetables are transplanted to the field in the fall, they are usually set at a time when rainfall is lacking and the temperature is high. This is very injurious to young unhardened vegetable plants. To improve plant livability in the field under such conditions, remove the plants from the float beds about 10 days prior to field transplanting and provide them with only enough moisture to keep them in good shape, but allow them to wilt slightly before applying water. This will harden the plants and enable them to better withstand the higher temperatures and lower moisture conditions likely to occur at the time of transplanting and for a few days thereafter. During the July or August temperatures, it may require at least one or two mistings per day to the plants to provide good plant livability during the hardening process.

Lettuce and mesculin greens

Very good-quality, but small-size, bibb-type lettuce such as Buttercrunch or Oak Leaf can be grown in the 18-cell trays. Due to a greater light intensity, yields of a spring crop will be about 25 percent greater than a fall crop grown in the same house. In the Knoxville area, consumers have shown a preference for the above two varieties. In 1996, a research trial that evaluated several varieties was conducted at the Plant Science Unit in Knoxville. From this trial, four varieties performed quite well. The best-performing looseleaf types were Simpson Elite and New Red Fire. Of the Bibb types, Ermosa and Summer Bibb were the better performers evaluated. If the consumer accepts the smaller plants, then growth can occur from seed to marketable plants in about six weeks in the spring, but it will require a little longer in the fall. Research experience to date indicates that lettuce taken directly off the float beds will wilt too rapidly for good sales. Therefore, a conditioning process of withdrawing the water should begin seven to 10 days before going to the market to allow the plant to develop stronger stalks and leaves so water loss after harvest is less of a problem.

Efforts have been made to grow and market float bed lettuce on 3/4- to 1-inch thick 4' x 8' Styrofoam® insulation sheets that float directly on the water. The 4' x 8' sheets are cut into 2' x 2' squares and 5/8" diameter holes are punched into the sheets with a round, thin, sharp instrument such as an aluminum or copper tube. The hole is then stuffed with cotton balls and lettuce seed placed directly on the cotton and allowed to germinate and grow as it floats on the water. Various fresh market outlets have exhibited interest in displaying the entire 2' x 2' sheet with fresh lettuce on the grocery shelf. The plants can be removed from the insulation sheets by lifting them through the hole or by cutting them off and placing them inside a plastic wrapper for transport to market.

This system of lettuce production appears to have some commercial appeal. Lettuce can be grown in a very confined area. It appears that several crops of lettuce can be grown in one year. The crop has the potential to be

supplied directly to market outlets in a very fresh state and it is less likely to be contaminated from soil splattering on the foliage or head. However, there is a potential for the bed to become contaminated with diseases if the plastic is not changed or rinsed with a sterilizing solution between crops. Before attempting to use the system to grow crops such as lettuce, a grower must study the market opportunities before investing heavily. The product produced looks very good, but it may not always fit into the existing marketing channels because of the packaging problems and consumer desirability. Packaging will need to be worked out by the grower to keep the product fresh, be convenient for the buyer and remain attractive to the consumer.

Allen Straw, at the Plateau Experiment Station, has been working diligently with mesculin green production in float beds for the past few years. Some interesting observations that he has made follow:

1. Todd Planter flats were acceptable containers, but when the seeds were broadcast over the tray, they tended to bounce away from the cell walls, resulting in a thick planting at the center of the cell. To reduce this problem, trays without cell dividers are needed to improve uniformity of plant distribution in the cell.



Photo 4. An 18-cell tray with different lettuce types grown on a float-bed.

2. Wholesale market personnel have indicated that mesculin mixes from indoor plantings seem too coarse-textured and light-colored for best market sales. Color and market texture appear to be more desirable when grown in outdoor beds.
3. Germination was not as uniform in the outdoor bed as it was in the indoor bed. Cool, wet weather prevented rapid, uniform germination and delayed maturity.
4. Yields were lower from the outdoor bed than from the indoor bed.
5. Lettuce seems to regrow faster when harvesting is done with a knife rather than with scissors. Scissors tend to crush the plant stem, resulting in injury and delayed growth.

One pick-your-own strawberry grower in East Tennessee used this method to produce fresh lettuce for sale while the customers purchase strawberries on the farm. Using this system increases the potential to add certain fresh vegetable products during on-farm sales of strawberries.

A disadvantage to float bed lettuce production is that there are no fungicides, bactericides or insecticides available if a fungus, bacteria or insect problem arises. The advantages, however, are that the product can be produced without becoming contaminated with soil particles. In addition, it can be sold with the roots attached and does not lose its fresh appearance.

Conventional Plant-Growing Practices

Growing containers:

Fibrous, plastic or polystyrene containers are commonly used for growing transplants. They provide for excellent drainage and air movement. If degradable fibrous containers are used, the entire container can be planted with a minimum of root disturbance. If polystyrene or plastic containers are used, plants must be removed before planting in the field. The roots must be thoroughly wet before transplanting and they must be covered with a minimum of one inch of soil after transplanting. The advantages and disadvantages of some of the more common growing containers are provided in Table 4.

Container size:

Research in Tennessee has shown that tomato plants develop better root systems and produce earlier yields if the container size is a minimum of 2 1/4 inches in diameter. Large container size is especially beneficial for early tomato yields, (photo 5) but is not as important for late yields.

With other crops such as broccoli, cabbage, cauliflower or pepper, the large container size is not as important as with tomatoes. The size most

Table 4. Advantages and disadvantages of common plant growing containers.

Container	Advantages	Disadvantages
Fiber block	Is easy to handle.	Roots may penetrate slowly.
Fiber tray	Provides maximum use of space.	Difficult to handle when wet.
Single peat pellet	Requires no media preparation. Uses less space for storage.	Requires individual handling at preparation time. Limited sizes available.
Single peat pot	Provides good root penetration through sidewalls if kept moist. Easy to handle in the field. Available in large sizes.	Separation is difficult. Dries out easily if left uncovered. Can wick moisture out of root zones if left uncovered.
Strip peat pots	Provides good root penetration if kept moist. Available in large sizes. Less time to prepare and fill.	Slow to separate in the field. Can act as a wick if allowed to dry.
Plastic flat with unit	Easy to handle. Reusable with sterilization.	Sizes may be limited. Requires storage during non-growing season.

commonly used with these crops is 1 1/4 to 1 1/2 inches in diameter, because they produce a large enough root ball for good livability at transplanting, and growth and maturity are early enough to meet market demands. In addition, they are also easily transplanted with conventional transplanters.

The vine crops, however, perform better if they are grown in the larger diameter containers (3-inch minimum) that can be transplanted directly to the field. The vine crops remain stunted if their root systems are disturbed during the transplanting process.



Photo 5. Tomato plants being grown in 3-inch diameter fiber containers.

Plant trays used for displays:

Trays used for displays of bedding plant sales are usually grown with six plants per tray. This is a good unit for plant growers who sell to home gardeners.

Growing media for containers:

Growing media should be loose to provide for gas exchange. The media should also be well-drained, fine-textured and free of insects, fungi, bacteria and weed seeds. The most commonly used media are pre-formulated mixes. Such mixes are recommended because of their adequate drainage, moisture-holding capacity and nutrient-retention capability. In addition, they are generally free of insects, disease pathogens and weed seed.

Pre-formulated mixes

Ready-made mixes are available through many garden, farm and horticultural supply stores.

They contain the necessary ingredients to provide good aeration and moisture-supplying capacity. These mixes do not require pasteurization prior to seeding, but sanitation, good ventilation and spray programs during growth are necessary to reduce the possibility of diseases such as "damping off." Commercially prepared, light-weight mixes are convenient and easy to handle. However, exercise care when adding fertilizers to pre-formulated mixes to avoid overstimulation of plants, since some of them already contain the necessary nutrients for plant growth. The finer-textured mixes available are good for seeding purposes, while medium-textured media is preferred for growing plants.

The following on-site mixes can be used, but they are used less than pre-formulated mixes because of the labor and time required to prepare them.

Soil mix

A good soil mix consists of one part shredded, sterilized soil; one part sand; and one part peatmoss, vermiculite or perlite. It is generally better to use soil mixtures low in fertility and add water-soluble fertilizers, if needed, while the plants are growing. However, mixes that use soil from any source are declining due to the availability, sterilization, improved seed emergence and overall convenience of pre-formulated mixes.

Homemade artificial media

Artificial media are used primarily because of a lack of uniform topsoil in many areas. Quite often, growers who use topsoil will find variability in soil fertility and physical condition from year to year that makes it difficult to grow uniform, good-quality plants. Herbicide contamination could be a serious problem if growers do not properly select non-contaminated soils. Thus, growers may desire to prepare their own media from one of the artificial mixes listed in Table 5 when growing in containers rather

Media sterilization:

If soil or sand is used in developing a homemade growing media, it should be sterilized to reduce damage from diseases and insects. Formulated commercial mixes which do not need sterilization are the most widely used and preferred media. Sterilization can be accomplished by using either chemicals or heat.

Chemical

Methyl bromide/chloropicrin mixtures are used for sterilizing plant beds or soil mixes in a bench-bed, but their use in greenhouse production is decreasing due to the availability of commercially prepared, sterile mixes. It can be applied at two pounds active material per 100 square feet. It should be released into shallow pans distributed at 30-foot intervals underneath a plastic film well-sealed at the edges to prevent escape of the gases. Methyl bromide is toxic to humans. Therefore, it should not be allowed to leak from under the plastic. Ventilators should be turned on during treatment to dissipate any escaping gas. Chloropicrin is tear gas, but it also has some pathogenic effects on certain diseases and, if smelled, signifies the presence of methyl bromide.

Methyl bromide fumigants are more effective if the soil is loose and friable, moist and with a temperature of 55F or above to a depth of 6 inches when application is made. If the temperature is 60F or above, the plastic can be removed after 24 hours. If it is below 55F, plastic should remain over the medium for at least 48 hours. After the film is removed, stir the medium and wait at least five days before seeding.

Heat

Steam or dry heat can also be used for sterilizing the growing medium in greenhouses or floatbeds, but it is less efficient than other methods. It is laborious, time-consuming and is decreasing in use for vegetable plant production in Tennessee.

Commercial growers can use steam heat for large volumes of mixes. The center of the medium should be raised to 160F and held for 30 minutes. Home gardeners who will be using only small quantities of a mix can sterilize by placing the medium into an oven not commonly used for cooking and maintaining the temperature conditions given above.

Container and structure sterilization:

Reusable plastic or polystyrene containers, tools and structures should be sterilized before reusing. This may be accomplished by dipping or spraying with a solution of one pound of copper sulfate per 25 gallons of water or a 10 percent solution of commercial bleach. If any of the above are used, rinse thoroughly and allow them to aerate two or three days before seeding or transplanting. When rinsing and aeration are not practiced, seeds and young plants are likely to be severely injured or killed.

Seeding

The best place to begin vegetable plant production is by purchasing good seed. New seeds have a high germination percentage. Since the price of seed is only about 5 percent of the total cost of growing plants, only the best seed should be used to insure a good return on the investment. Good plants cannot be grown from poor seed. For specific seeding details, refer to Tables 6 and 7.

Table 5. Examples of artificial mixes.

No. 1		No. 2	
Material	Amount/yd ³	Material	Amount/ yd ³
Spaghnum peat	11 bu.	Shredded peatmoss	11 bu.
Vermiculite	11 bu.	No. 2 vermiculite or perlite	11 bu.
Ground limestone	5 lbs.	Ground dolomitic limestone	2 lbs.
Superphosphate (0-46-0)	1/2 to 1 lb.	Superphosphate (0-46-0)	4 oz.
Calcium or potassium nitrate	1 lb.	6-12-12 fertilizer	5 lbs.
Minor elements ¹ Wetting agent (Detergent) ²	3 oz./gal. of water	Wetting agent (Detergent) ²	3 oz./gal. of water
<p><i>1. Add a water-soluble minor element mix in accordance with the manufacturer' s directions.</i> <i>2. Spread peat and spray before mixing.</i></p>			

Mechanical seeders

When large numbers of trays are to be seeded quickly, mechanical seeders are available to both fill the tray or cells with pre-moistened media as they pass continuously on a conveyor underneath a bin chute filled with growing media. Excess media is removed to fill the tray or cell level full. The tray is also rolled under an automatic rolling dibbler which forms media depressions into which the seed is inserted. Dibbles of the proper spacing and depth are made as needed in each tray, seed are dropped into the dibble and covered with a slight layer of a low density material such as perlite to improve seed emergence. Almost all large scale plant producers now seed directly into the container they intend to use to grow the plants rather than planning to do hand transplanting after plants reach the appropriate height. A basic illustration is provided in Figure 4.

Hand seeders

If seeding is to be done in trays with plans to transplant the seedlings to growing cells after emergence, then the following procedure can be used. First, fill the seeding container to within about 1/2 inch of the top and moisten it if the medium is dry. Next, add moisture before seeding to avoid floating the seed out of the media. Provide adequate drainage in the seeding tray. Level and gently firm the planting medium with a small, clean board. With a

large wooden label, self-made dibble board or other suitable instrument, make rows of the desired depth about 1 to 2 inches apart in the tray (see Figure 5).

Plant only one kind of seed per row, label and date for identification purposes. Sow the seed uniformly in the rows at a depth about twice the diameter of the seed. For those crops that transplant well, such as tomatoes, pepper, cabbage, broccoli or cauliflower, allow them to reach the desired size and then transplant them to individual growing containers and cells. After transplanting, allow five to seven weeks to grow the plants (see Table 6).

Since they will not transplant well, vining vegetables such as cucumbers, cantaloupes, pumpkins, watermelons and squash should be seeded directly into fibrous containers that can be set in the field. Seed these crops two to three weeks ahead of field planting dates.

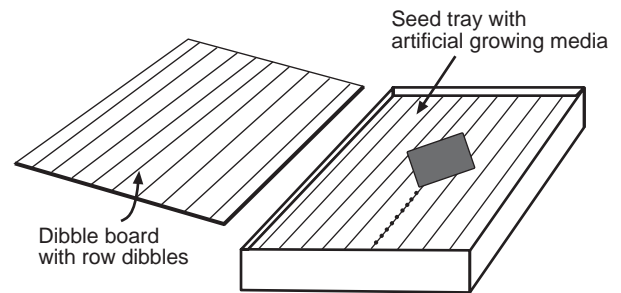

Figure 5. Seeding tray for conventional plant production techniques.

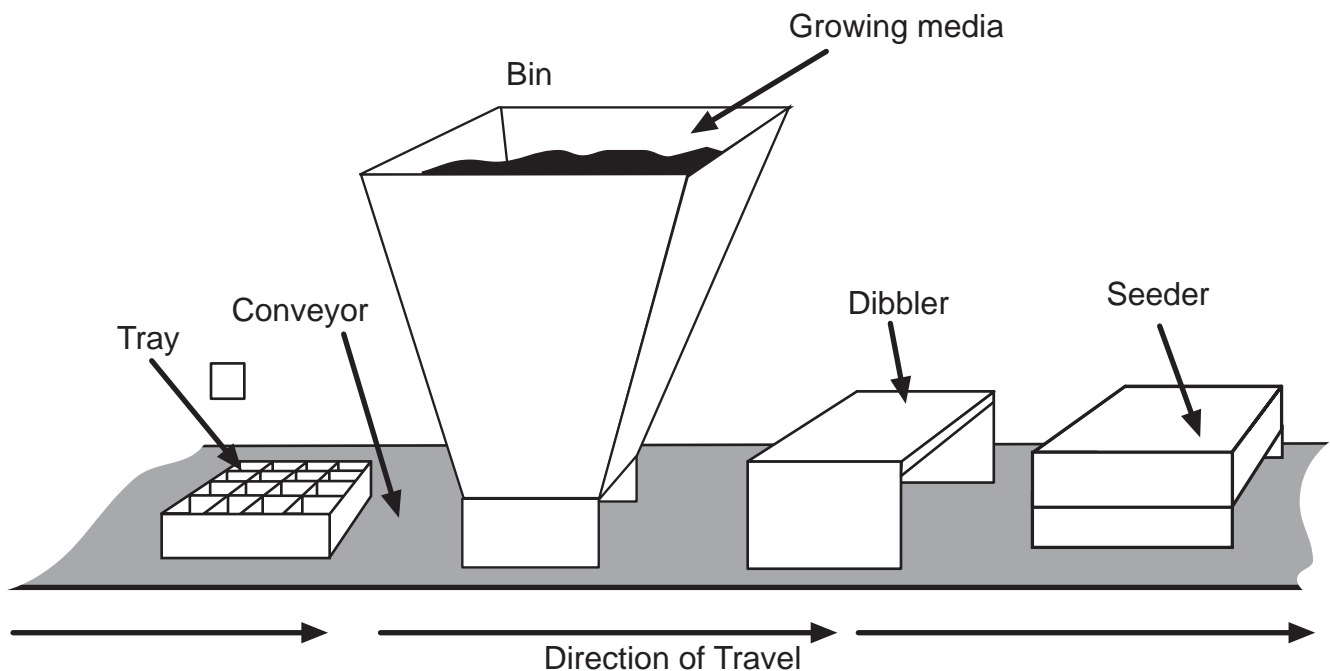

Figure 4. Illustration of mechanical seeder required for a large number of trays

Cover the seed with sterilized sand, vermiculite or shredded peat moss. Moisten the surface with a fine mist. Cover the container with glass, newspaper or clear plastic and place the seed at the desired temperature for germination (see Table 6). When the young seedlings have emerged, uncover the container to prevent damage to them and keep at the desired temperature for growth. Do not delay uncovering the young seedlings since they are likely to be damaged.

Space requirements for transplant production:

The approximate spaces required for growing the number of plants required per acre based on population per acre and container sizes are summarized in Table 7.

Transplanting from seed containers:

When the first true leaves of transplantable vegetables appear, transplant them into individual containers or cells. The first leaves to appear are cotyledonary or seed leaves (see Figure 6). The second leaves to appear are the true leaves. A plant is usually 1½ to 2 inches tall when this occurs. Seedlings of this size are large enough to be transplanted. They can be transplanted without excessive shock at this stage unless they have been grown under conditions of high nitrogen and low light intensity. For best plant quality and livability, grow the seedlings with adequate water, low fertilizer and full sunlight.

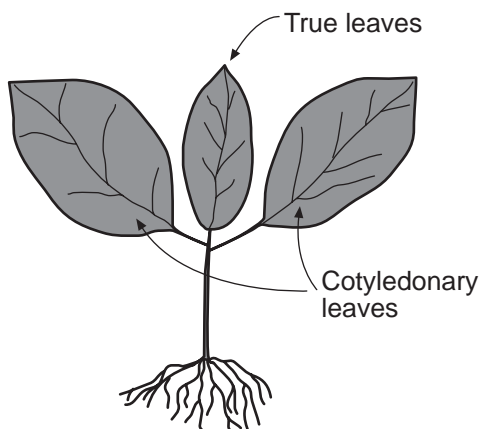

Figure 6. Transplantable stage.

Fill individual containers to about ½ inch from the top. Moisten the media and with a bluntly pointed wood dowel about 3 to 4-inch in diameter or a finger, make a hole for the seedling. Large growing operations accomplish this mechanically. To avoid breaking the roots, moisten the seeding tray and lift the seedlings out by the roots using a thin wooden label, broad knife or other similar tool. Place the seedling about 1 inch deep in the medium and firm the soil around the plant.

When a number of seedlings have been transplanted, place the containers in the growing area and water thoroughly before wilting occurs. For the first two or three days after transplanting, keep the soil media moist until it is evident that the plants have started growing. At this point, maintain only sufficient levels of moisture in the growing media to keep the plants healthy. Saturated conditions in the growing media can result in transplant production problems, such as rapid growth or increased susceptibility to “damping off” organisms.

Management practices for growing transplants:

Management practices after transplanting the seedlings to individual containers or cells are important in producing stocky, healthy plants that are productive once they are set in the field. These practices apply regardless of the growing structure used.

Damping-off

“Damping-off” is the most common seedling disease attacking plants grown in greenhouses or hotbeds. The first symptom of this fungus is the falling over of seedlings at the ground line (see Figure 7). The fungus produces a decayed ring around the stems, causing them to fall over. Damping off is encouraged by wet growing media, excessive nitrogen fertilization and high temperatures, even though the media may have been pasteurized. It can be reduced by good ventilation, spraying the seeding containers and individual containers with a fungicide, avoiding over-watering and being careful not to apply excessive levels of nitrogen to over-stimulate the plants. For further control recommendations, refer to Extension PB 1282, “**Commercial Vegetable Disease, Insect and Weed Control,**” available at your county Extension office.

Table 6. Seedling Guide for Most Commonly Grown Vegetable Crops.

		Approximate Date of Seeding				Ideal Temperature F.		
Vegetable	Seed Required to Produce 10,000 Plants	Spring	Fall	Seeding depth (inches)	Approximate Growing Time (wks)4/	Germination	Growing	Conditions for Hardening
A. Cool-season^{1/}								
Broccoli ^{2/}	2 oz.	Feb. 1	July 5	1/4-1/2	5-7	70	60-65	50-55 degrees for 10 days.
Brussels Sprouts	---	---	---	---	---	---		-----
Cabbage	2 oz.	Feb. 1	July 5	1/2	5-7	70	60-65	50-55 degrees for 10 days
Cauliflower ^{2/}	2 oz.	Feb. 1	July 5	1/4-1/2	5-7	70	60-65	50-55 degrees for 10 days
Head Lettuce	1 oz.	Feb. 1	---	1/4	5-7	70	60-65	Lower temperature and moisture.
Leaf Lettuce	1/2 oz.	Feb. 1	July 25	1/4	3-4	70	60-65	Lower temperature and moisture.
Warm-season^{1/}								
Cucumber ^{3/}	1 1/4 lb.	Apr. 10	July 5	3/4-1	2-3	75	65-75	Reduce moisture.
Cantaloupes ^{3/}	1 1/4 lb.	Apr. 10	June 10	3/4-1	2-3	75	65-75	Reduce moisture.
Eggplant	4 oz.	Mar. 5	---	1/4-1/2	6-8	75	70-75	Reduce temp./moisture.
Pepper	7 oz.	Mar. 5	---	1/4-1/2	7-9	75	60-70	Reduce temp./moisture.
Squash ^{3/}	3 1/4 lb.	Apr. 10	July 10	3/4-1	2-3	75	65-75	Reduce moisture.
Tomato	2-3 oz.	Mar. 5	June 1	1/4-1/2	5-7	75	60-70	Reduce temp./moisture.
Watermelon ^{3/}	3 1/4 lb.	Apr. 10	May 10	3/4-1	2-3	80	65-75	Reduce moisture.

1/ Cool-season crops are frost-tolerant and can be set in the field before the last frost. Warm-season crops are susceptible to frost and should not be set until frost danger is past.
2/ Do not allow to become deficient in nitrogen or water or expose to cold temperatures when they are small.
3/ Seed into individual containers that will be placed in the field, because these crops will not transplant easily. A slight disturbance of the roots will induce heavy shock to these plants. The minimum size container should be 3 inches. They cannot be hardened by reducing the temperature.
4/ Allow about 10 days extra growing time if grown in plant beds. Plants produced on float beds in the fall will be ready about 10 days ahead of conventionally grown plants.

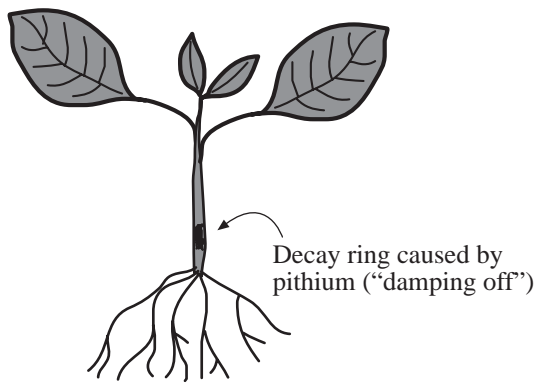

Figure 7. Illustration of “damping off” symptom.

Good ventilation and low humidity are very important in reducing the incidence of damping-off. Keep air moving through the growing area continuously during bright, shiny days.

Temperature

Better-quality, more productive plants are produced when the night temperature is about 10 degrees lower than the day temperature. The more experienced plant growers understand the importance of keeping the growing temperatures as close to the ideal as possible. Unfortunately, many grow-

ers want to keep the greenhouse too hot during the plant-growing phase. Ideal growing temperatures are given in Table 6.

Temperatures should be maintained within a five-degree range of those given in Table 6. If temperatures are too low, growth is slow and some purpling of the leaf veins occurs with many vegetable species. This is a good visual symptom that plants are being hardened, which is a good practice for early transplants. A purple color may also signify that phosphate levels or uptake are low and may require an adjustment. When the temperature is too high, growth is soft, resulting in tall, tender unproductive plants. Soft, tender and elongated plants are susceptible to injury by wind and hot, dry weather after transplanting to the field. Plants with green veins are usually tender and respond unfavorably when exposed to adverse weather. They must be hardened before transplanting to the field.

Day and night temperature management

The differences between the day and night temperatures (DIF) can also be used to control plant height or growth. With a negative DIF, the day

Table 7. Growing Area (ft.²) Required for Varying Plant Populations Per Acre Using Different Container Sizes

		Area Required ^{1/} For Container Sizes of:		
Crop	Plants Per Acre	1 1/2 in	2 in.	3 in.
1. Tomatoes	5,000	8' x 10'	8' x 18'	10' x 32'
	4,000	8' x 8'	8' x 14'	10' x 25'
	3,000	7' x 7'	8' x 11'	10' x 19'
2. Cole Crops (Cabbage, Broccoli, Cauliflower)	30,000	10' x 47'	10' x 84'	---
	20,000	10' x 32'	10' x 56'	---
	10,000	10' x 16'	10' x 28'	---
3. Pepper, Eggplant	8,500	8' x 17'	8' x 30'	---
	7,500	8' x 16'	8' x 28'	---
	6,500	8' x 15'	8' x 26'	---
^{1/} To meet requirements for maintaining plants, and accounting for plant defects, add about 20 percent to the area requirements given above.				

temperature is cooler than night temperature. Plants that are grown with a positive DIF are usually taller than those grown with a negative DIF. The DIF system is not applicable for germination, but is initiated when the first true leaves appear. It requires the capability to control the greenhouse temperature and is applicable to growing regions where the day temperatures in the spring are cool and the greenhouse can be heated. However, the cost of heating can be an economic disadvantage. Plant responses to the DIF system are provided in Table 8.

Watering or irrigating

Over-watering is a common problem in growing vegetable plants. Unfortunately, it is worse than inadequate watering. Watering should be done often enough to keep the growing medium moist, but not saturated. Water in the mornings so the foliage and soil surface will dry before night. Use a mist nozzle and do not knock over the seedlings. Soak the media thoroughly at each watering, but let the soil surface dry before watering again. If necessary, allow the plants to wilt slightly before watering to avoid the production of excessively tall, tender plants that do not recover rapidly when exposed to adverse weather conditions. Slight wilting contributes to the production of hardened plants that respond well after transplanting to the field. Refer to Figure 1 for watering methods.

Table 8. Vegetable transplant response to the differences in day and night temperature (DIF).

Crop	Response to DIF ¹
Broccoli	3
Cabbage	3
Cauliflower	3
Cucumber	1 - 2
Eggplant	3
Muskmelon	3
Pepper	0 - 1
Squash	2
Tomato	2
Watermelon	3
¹ 0 = No response; 3 = strong response	

Light

Maintain as much full sunlight during the growth of vegetable transplants as possible. Vegetable plants grown in full sunlight will be stockier and more productive than those grown in shady conditions. Low-light intensity contributes to the production of excessively tall, tender plants that are slow to recover when exposed to unfavorable weather conditions in the field. Such plants are usually low yielders after transplanting to the field.

Ventilation

Air movement is necessary to reduce excessive humidity and maintain the desired temperature. Good air circulation will help keep foliage and soil surfaces dry and reduce diseases. Good ventilation with proper watering practices encourages the growth of healthy, stocky plants that are less susceptible to “damping-off” in the greenhouse and to wind and weather injury in the field. Proper ventilation will also aid in the reduction of disease problems that can increase due to high humidity. Thus, when constructing a greenhouse, it is better to plan for the capability to over-ventilate than to under-ventilate. A general recommendation for ventilation is that the fans be large enough to change the entire volume within the house at least once per minute if necessary. The more air moving through the greenhouse, the better for plant growth and disease control. Condensation in the top of the house can be reduced by beginning ventilation in the top of the house during cooler temperatures. Reducing condensation reduces humidity. This reduces the potential for foliar disease development.

Fertilization

Vegetable seedlings will need some fertilization for best development. However, young tender seedlings are easily damaged by too much fertilizer. Do not apply nitrogen fertilizer on a weekly basis because this may induce rapid growth, which also results in excessively tall, unproductive plants. This is a good way to cause tomato plants to set their first cluster too high above the soil surface. This reduces the total number of clusters that a plant can produce and may reduce yields by as much as 8 to 9 percent per plant. When plants slow down in growth and become pale yellow, use a

water-soluble fertilizer according to the manufacturer's directions or fertilize with a stock solution containing one of the following concentrations provided in Table 2.

The frequency of applying fertilizer depends on the needs of the plant and the concentration of the nutrients in the fertilizer solution. As the concentration of fertilizer nutrients in the fertilizer solution increases, the number of applications needed to apply a given amount of fertilizer decreases. For further details on fertilization levels, refer to Tables 2 and 3.

Spacing

To further reduce the possibility of producing tall, tender plants, it is a good idea to space plants (not the containers) 2 to 3 inches apart. This can be easily accomplished by using 2- to 3- inch diameter containers or cells for growing crops such as tomatoes and pepper as well as those crops such as cantaloupes, cucumbers, squash or watermelon that do not withstand transplanting well. Broccoli, cabbage, cauliflower or the cole crops can be satisfactorily grown in containers or cells that are 1¹/₄ to 2 inches in diameter.

Diagnosing and Correcting Vegetable Transplant Disorders:

The transplant disorders and corrective measures shown in Table 9 will aid in diagnosing and correcting vegetable problems during the plant-growing stage.

Hardening Plants

Plants which have been growing indoors cannot be planted abruptly into the field without injury. To reduce injury due to adverse weather, especially in the spring, plants should be "hardened" before planting outdoors.

Hardening should begin two weeks before field planting. To harden, plants can be moved to cooler areas outside, or the temperature can be reduced in the present location. Moving plants to a coldframe is an excellent way to harden plants. When moved outdoors, keep plants in the shade at first, but gradually move into full sunlight by increasing the period of exposure each day. Reduce the frequency of watering to slow growth. Slight wilting will

toughen plants. Even cold-hardy plants such as cabbage will be damaged if exposed to freezing temperatures before they have been hardened. After hardening, some plants can be exposed to light frosts without being injured. Almost all of the cool-season crops can be hardened, but warm-season, vining crops cannot be hardened by reducing the temperature. They cannot tolerate cool temperatures. If exposed, they will usually be stunted. Conditioning treatments for them involves reducing water and fertilizer.

One of the visual symptoms for hardened plants is a slight purplish color which develops in the veins.

For hardening conditions required for specific vegetables, refer to Table 6.

Summary

Successful plants can be produced by following the ideas described below.

1. Properly construct and equip the desired plant-growing structure.
2. Begin with seed that are viable, disease-resistant or that have been treated to prevent diseases and have a high percentage of germination.
3. Select and grow cultivars that are well adapted and high yielders of a product highly desired by the consumer.
4. Use a growing medium that is loose and friable, free of disease and that provides good drainage, water-holding capacity and nutrient retention capability.
5. Grow only in sterilized media, containers and structures. Follow strict sanitary practices.
6. Follow proper seeding procedures.
7. Germinate and grow plants according to their optimum temperature, moisture and fertilizer requirements. Keep plants and soil from remaining wet for long periods of time.
8. Transplant tomatoes into 2- or 3-inch containers for early yields. Seed the cucurbits into larger diameter (3-4 inch) containers that will be planted in the field. Cole crops do not need to go into large containers.
9. Maintain spray programs to control insects and diseases.
10. Maintain proper ventilation, temperature, water and fertilization requirements.
11. Harden plants before field setting.

Table 9. Vegetable plant disorders and corrective measures

Symptom	Possible Cause	Corrective Measure
1. Spindly growth	Shade, cloudy weather, excessive water, high temperature or nitrogen and insufficient growing space.	Provide full sun, reduce temperature, restrict watering, ventilate or reduce night temperature, fertilize less frequently, provide adequate space.
2. Dwarf Plants	Low fertility	Apply appropriate fertilizer frequently in low concentrations.
A. Purple leaves	Phosphorus deficiency or excessively cool temperatures.	Apply a water-soluble fertilizer high in phosphate such as 10-52-8 or an equivalent fertilizer. (1 oz. per gallon of water and apply to 10-12 sq. ft. of bed space).
B. Yellow leaves	Nitrogen deficiency	Apply a nitrogen fertilizer such as 30-10-10 or equivalent fertilizer (1/3 oz. per gallon of water and apply to 10-12 sq. ft. of bed space).
C. Discolored roots and marginal necrosis of leaves	High soluble salts from over- fertilization, or high soluble salts from poor soil pasteurization.	Leach the soil by excessive watering. Avoid over-fertilization. Do not sterilize at temperatures above 160F.
D. Interveinal yellowing of leaves	Either magnesium deficiency or manganese toxicity.	Check soil pH and correct or apply appropriate nutrient.
3. Tough, woody plants	Over hardening	Apply plant starter fertilizer as discussed under phosphorus deficiency three to four days before transplanting outdoors. Avoid over-exposure during the hardening process.
4. Water-soaked, decayed stems near soil surface. Seedlings fall over.	Damping-off	Use a sterile, well-drained medium. Adjust watering and ventilation practices to provide a less moist environment. Use recommended fungicidal drenches. See PB1282, " Commercial Vegetable Diseases, Insect and Weed Control " available at the county Extension office.
5. Poor root growth	Poor soil aeration. Poor soil drainage. Excessively dense media. Over-watering. Low soil fertility. Low temperature. Root rot fungi. Chemical residue such as chlorine residue from improper container sterilization.	Evaluate the causes and take appropriate corrective action.
6. Green algae or moss growing on soil surface, especially in shady areas or during cloudy weather.	High soil moisture	Adjust watering and ventilation practices to provide less moist atmosphere. Use a better drained growing medium.
7. Distortion, crinkling, cupping, rolling or bending of leaves and stems.	Chemicals, such as those leaked from improper heating systems, herbicide residue or contamination.	Evaluate various sources of chemical contamination and take appropriate corrective action.

PB819-5M-8/99 E12-2015-00-060-00

The Agricultural Extension Service offers its programs to all eligible persons regardless of race, color, national origin, sex, age, disability, religion or veteran status and is an Equal Opportunity Employer.

COOPERATIVE EXTENSION WORK IN AGRICULTURE AND HOME ECONOMICS

The University of Tennessee Institute of Agriculture, U.S. Department of Agriculture,
and county governments cooperating in furtherance of Acts of May 8 and June 30, 1914.

Agricultural Extension Service

Billy G. Hicks, Dean